

Wireless Base Station Single and Multiple Headsets Operation Manual



7340 SW Durham Road • Portland, OR 97224 USA
Phone: 503-684-6647 • 1-800-527-0555
Fax: 503-620-2943 • email: sales@firecom.com



www.firecom.com

TABLE OF CONTENTS

| | |
|---------------------------|-----|
| Overview | 2 |
| Base Station Models | 2 |
| Installation | 3 |
| Pairing | 4-6 |
| Troubleshooting | 7 |
| Specifications | 8 |
| Package Contents | 9 |
| Warranty | 9 |

OVERVIEW

This manual describes single headset and multiple headset wireless base station models to be used with the Firecom UHW/FHW wireless headset series. Together, with the UHW/FHW wireless headset series, the base stations provide secure, interference free communications for operators of fire and emergency trucks.

BASE STATION MODELS

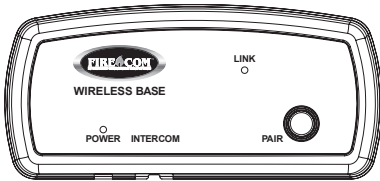

**Single Headset Base Station
30XXR Intercom Compatible**

Single Headset Base Station

This model accommodates a single UHW/FHW series radio transmit wireless headset. The base station can be connected via a 6 conductor flat cable to any headset port on Firecom's 30XXR series intercoms. The base station will provide full duplex audio and PTT communication between the wireless headset and the intercom.

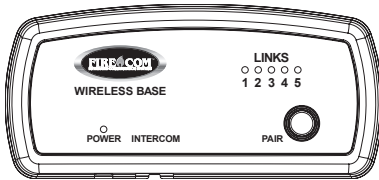

**Multiple Headset Base Station
30XXR Intercom Compatible**

Multiple Headset Base Station

This model accommodates up to five UHW/FHW series non-radio transmit wireless headsets¹. The base station can be connected via a 6 conductor flat cable to any headset port on Firecom's 30XXR series intercoms. The base station will provide full duplex audio communication between the wireless headset and the intercom.

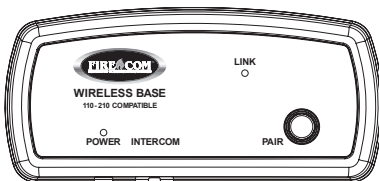

**Single Headset Base Station
110/210 Intercom Compatible**

Single Headset Base Station, Firecom's 110/210 Intercom Compatible

This model accommodates a single UHW/FHW series radio transmit wireless headset. The base station can be connected via a 6 conductor flat cable to any headset port on Firecom's 110 radio interface or 210 intercom. The base station will provide full duplex audio and PTT communication between the wireless headset and the intercom.

Note: Any combination of up to 40 radio-transmit and non radio-transmit headsets connected to single and multiple headset bases can operate simultaneously, in close proximity to each other, for interference free communications².

INSTALLATION

- It is recommended that the base station be mounted high on the truck window, not within 4 inches of any metal³. The base station should be attached to the window with 1/4" thick, double-sided tape, to help insulate the base station from the cold. When mounted vertically, the base station should be oriented so that cables into the base station are connected from the bottom, not the top of the enclosure so as not to provide a water path into the enclosure.
- Connect nominal 12V (11-16V) from the truck to the base station using the power cable provided. The base station can be connected to the vehicle power line and ground at any location on the truck, without risking undesired effects such as ground loops, etc. Connect the black wire to the vehicle's ground and the red wire to the vehicles 12V power. When wired separately from the intercom, use a separate 1A ATO fuse for the base station. However, if wired to the same power source as the intercom, the base station can be connected through the same 1A ATO fuse provided with the intercom.
- Plug one end of the enclosed 6P6C RJ-12 modular communication cable into the RJ-12 jack on the base station and the other end into any headset port on the intercom⁴.

NOTE: When crimping the 6P6C modular plugs, always make sure the printed side of the cable is facing the release tab on the plug on both ends of the RJ-12 modular cable.

- To provide strain relief for the power cable, use a wire tie to tie the modular communication cable to the power cable. Place the wire tie as close to the base station as possible.

The RJ-12 Modular Plug

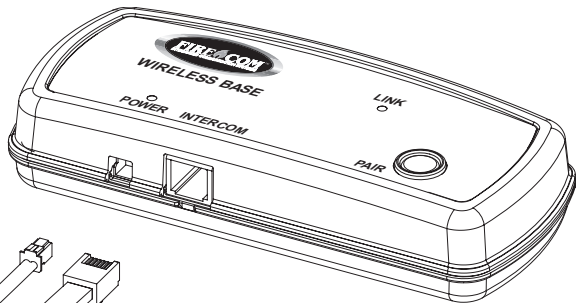
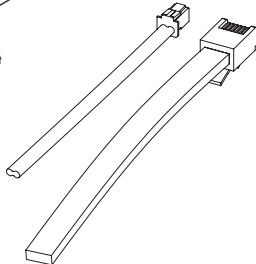
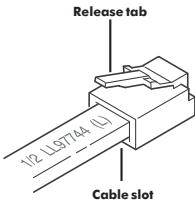

PAIRING

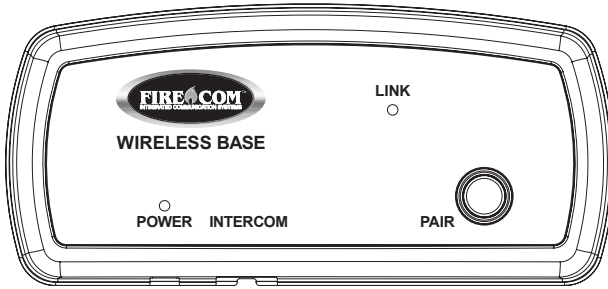

Single Headset Base Station

Single Headset Base

1. When the base station is first powered, the green LED labeled POWER on the bottom left of the front panel will illuminate steadily. The single LINK yellow LED will either stay unlit, indicating that no headsets have been previously paired to the base, or will start flashing rapidly, indicating that a headset has been previously paired to the base station⁵.
2. Press and hold the pairing button in the bottom right corner of the base station for approximately 5-7 seconds. The LINK LED will start flashing slowly to indicate that the base station has been placed in pairing mode. Once the base station is placed in pairing mode, the user has approximately 15 seconds to place the headset in pairing mode.
3. Place the headset in pairing mode; refer to the UHW/FHW series user's manual for information regarding how to put the headset in pairing mode. The red and green LEDs on the headset will alternate rapidly to indicate that the headset is in pairing mode.
4. After about 5-7 seconds, the green LED on the headset and the yellow LINK LED on the base station's front panel will flash rapidly for two seconds then turn on steadily to indicate that a link has been established between the headset and the base. At this point, full duplex audio communication between the headset and the base station is enabled.

PAIRING

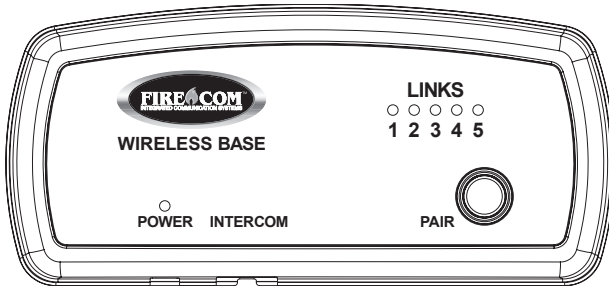

Multiple Headset Base Station

Multiple Headset Base

The multiple headset base station is equipped with 5 yellow LINK LEDs on the front panel. Each LINK LED represents a headset position with position #1 represented by the leftmost LED. The pairing priority is given starting with position #1 and ending with position #5. **It is recommended that pairing to new headsets is done one headset at a time.**

1. When the base station is first powered, the green LED labeled POWER on the bottom left of the front panel will illuminate steadily. Every one of the five LINK yellow LEDs will either stay unlit, indicating that no headset has been previously paired to that particular headset slot, or will start flashing rapidly indicating that a headset has been previously paired to that particular headset slot⁵ but is not currently linked.

NOTE: If any headsets have been previously paired to the base station and the intent is to keep them paired, then these headsets must remain turned on and linked in steps 1 through 3 of this procedure. An active link to a headset is indicated by the respective LINK LED on the front panel of the base station being steadily illuminated.

2. Press and hold the pairing button in the bottom right corner of the base station for approximately 5-7 seconds. The respective LINK LEDs for any headset that is currently linked to the base station will remain steadily illuminated. However, LINK LEDs for vacant slots and for occupied slots with no actively linked headsets will start flashing slowly to indicate that the base station has been placed in pairing mode and that these slots have been made available for pairing. The highest priority slot will be assigned to the headset currently being paired. Once the base station is placed in pairing mode, the user has approximately 15 seconds to place the headset in pairing mode.

PAIRING

3. Place the headset in pairing mode; refer to the UHW/FHW series user's manual for information regarding how to put the headset in pairing mode. The red and green LEDs on the headset will alternate rapidly to indicate that the headset is in pairing mode.
4. After about 5-7 seconds, the green LED on the headset and the respective yellow LINK LED on the base station's front panel will flash rapidly for two seconds then turn on steadily to indicate that a link has been established between the headset and the base. At this point, full duplex audio communication between the headset and the base station is enabled.

Note: It is only necessary to pair a headset to a base station once. After that, if power is turned off to the headset or base station, the pairing settings will not be lost in either the headset or the base, as those settings reside in indelible memory on both devices

Footnotes

- 1- Five headsets can be paired to a multiple headset base, but only four headsets can be connected and communicated through the base at any given time.
- 2- Under certain site conditions, it may be possible to operate up to 50 headsets in close proximity.
- 3- Due to the excellent coverage range the wireless system provides, the base may be mounted in different locations inside the cab, such as the top surface of the dashboard close to the front windshield. Care should be taken when the base station is mounted in such locations in order to ensure that the base station and its wiring are not damaged due to accidental bumping or piling up of additional working gear.
- 4- In the case of radio transmit single headset base, if transmit priority is desired, then the communication cable from the base station should be plugged into headset port marked PR.
- 5- If the LINK LED flashes rapidly at power up, then it is an indication that a headset has been previously paired to the base. The previously paired headset will not need to be paired again to the base station and turning the power on to the headset will make it link to the base station.

TROUBLESHOOTING

When properly located, installed and powered, the base station will perform reliably with no anticipated problems.

Note: If the symptoms you are experiencing are not covered in this manual, or if you are having difficulty troubleshooting your system, contact your local Firecom dealer for assistance or see www.firecom.com for additional information.

Problem: No indication of power to the base station (green power indicator does not illuminate).

- Check wiring to the base station.

Problem: No audio communication and/or PTT from or to the base.

- Ensure that power is turned on to the wireless headset(s) and that the headset(s) are connected.
- Ensure that the modular communication cable is connected between the base station and intercom.
- Check the modular communication cable between the base station and intercom for continuity.
- Ensure correct polarity of the 6P6C plug on both ends of the modular cable (refer to "Installation" section).

Problem: Poor quality audio, low or distorted received or transmitted audio.

- Ensure that the volume level is properly adjusted on the intercom. For 30XXR series intercoms, it is recommended that the volume level is set as high as possible on the intercom without causing distorted audio on the headset side, and that the volume control on the headset is adjusted for comfortable listening.
- Poor quality audio can also be caused by a defective headset. Check operation with a known, well functioning headset in order to determine whether the problem is attributed to the base station.
- Ensure that the proper base station model for your intercom is used.

Problem: Audible interference from portable and mobile radios.

- The wireless system is tested and proven to be immune to interferences from portable and mobile communication equipment operated anywhere in the frequency spectrum from 30MHz to 18GHz. However, care should be taken with installation of communication cables between the intercom and the base station. These cables should be routed away from portable and mobile radios and antenna cabling in order to prevent RF interference from such devices.

Problem: Poor coverage range.

- Check location of the base station on the vehicle. The base station should not be installed inside metal enclosures or any other location closer than 4 inches to a metal object or surface.
- Poor range can also be caused by a defective headset. Check operation with a known, well functioning headset in order to determine whether the problem is attributed to the base station.

SPECIFICATIONS

Electrical:

- Power: Nominal 12V (11-16V)
- Current draw: 45mA average, 80mA peak
- Reverse voltage protection
- Immune to ESD and transients per SAE standard J1113
- EMC compatible per SAE standard J1113

Mechanical:

- Dimensions: 5.7"L x 2.6"W x 1.14"H
- Weight: 4.24 oz (0.265Lb)

Environmental:

- Operating temperature range: -10 to +70°C
- Storage temperature: -25 to +85°C
- Meets SAE standards J1455
- Chemical resistance, corrosion and humidity per MIL-STD-810

RF:

- Range: 1100' open field, 100' minimum depending on where the base station is installed on a fire or emergency truck.
- Secured digitally encoded interference free communications.
- Any combination of base stations or headsets for a total of 40 headsets working together in close proximity.

FCC/IC Compliance:

This device complies with FCC Part 15 Rules and IC RSS-213 Rules. Operation of this device is subject to the following two conditions:

1. This device may not cause harmful interference.
2. This device must accept any interference that may be received, including interference that may cause undesired operation.

FCC/IC RF Exposure Warning:

- This product complies with FCC radiation exposure limits set forth for an uncontrolled environment.
- To comply with FCC RF exposure requirements, the base unit must be installed and operated 20 cm (8 inches) or more between the product and all person's body (excluding extremities of hands, wrist and feet).
- This product may not be collocated or operated in conjunction with any other antenna or transmitter.

PACKAGE CONTENTS

Single Headset Base Station: P/N 106-3089-00

- Single headset base station: P/N 950-3089-00
- Power cable, 9': P/N 420-0047-00
- Modular communication cable, 16': P/N 400-0009-00
- Modular plug 6P6C, 2ct, P/N 351-0002-07
- User's manual: P/N 600-0075-00

Multiple Headset Base Station: P/N 106-3086-00

- Multiple headset base station: P/N 950-3086-00
- Power cable, 9': P/N 420-0047-00
- Modular communication cable, 16': P/N 400-0009-00
- Modular plug 6P6C, 2ct, P/N 351-0002-07
- User's manual: P/N 600-0075-00

Single Headset Base Station, 110/210 Series Intercom: P/N 106-3094-00

- Single headset base station: P/N 950-3094-00
- Power cable, 9': P/N 420-0047-00
- Modular communication cable, 16': P/N 400-0009-00
- Modular plug 6P6C, 2ct, P/N 351-0002-07
- User's manual: P/N 600-0075-00

ACCESSORIES

- 30XXR intercom to dual base adapter cable: P/N 420-2142-00
- 110/210 intercom to dual base adapter cable: P/N 420-2143-00

Changes or modifications not expressly approved by Firecom can void the user's authority to operate the equipment.

If a problem persists in the device, contact Firecom for a Return Merchandise Authorization (RMA) number. Return the device for replacement or repair.

CONTACT: Firecom
7340 SW Durham Road
Portland, OR 97224
1-800-527-0555
USA

WARRANTY

Two-Year Limited Warranty to the Original Purchaser

Sonetics Corporation warrants to the original purchaser of its products, that they will be free from defects in materials and workmanship, under normal and proper use, for the period of two years from date of purchase. Sonetics Corporation will repair or replace, at its option, any parts showing factory defects during this warranty period, subject to the following provisions. This warranty applies only to a new product which has been sold through authorized channels of distribution. All work under warranty must be performed by Sonetics Corporation. All returned products must be shipped to our address, freight prepaid, accompanied by a dated proof of purchase. The purchaser voids this warranty if he, she or others attempt to repair, service or alter the product in any way. This warranty does not apply in the event of accident, abuse, improper installation, unauthorized repair, tampering, modification, fire, flood, collision, or other damage from external sources, including damage which is caused by user replaceable parts (leaking batteries, etc.). This warranty does not extend to any other equipment or apparatus to which this product may be attached or connected. The foregoing is your sole remedy for failure in service or defects. Sonetics Corporation shall not be liable under this or any implied warranty for incidental or consequential damages, nor for any installation or removal costs or other service fees. This warranty is in lieu of all other warranties, express or implied, including the warranty of merchantability or fitness of use, which are hereby excluded. To the extent that this exclusion is not legally enforceable, the duration of such implied warranties shall be limited to two years from date of purchase. No suit for breach of express or implied warranty may be brought after two years from date of purchase.



FIRECOM is a division of Sonetics Corporation
7340 SW Durham Road • Portland, Oregon 97224
800-527-0555 • 503-684-6647 • Fax: 503-620-2943
Email: sales@firecom.com • www.firecom.com

Copyright © 2008 Sonetics Corporation - All rights reserved.

The information in this document is subject to change without notice.

No part of this document may be reproduced in any form without prior written consent of Sonetics Corporation.

This document is part number 600-0075-00 RevC. Patent pending.