

# **panther**CCS

## Intercom System Operation Manual



7340 SW Durham Road • Portland, OR 97224 USA  
Phone: 503-684-6647 • 1-800-527-0555  
Fax: 503-620-2943 • email: sales@firecom.com



[www.firecom.com](http://www.firecom.com)

# TABLE OF CONTENTS

<b>Safety Information</b>	
Overview .....	2
<b>Features</b> .....	3
<b>Intercom Models</b> .....	4
<b>Operation</b> .....	4
<b>Installation</b> .....	5
<b>Wire Connections</b> .....	6
<b>System Wiring</b> .....	7
<b>Troubleshooting</b> .....	8
<b>Options and Accessories</b> .....	9
<b>Maintenance</b> .....	9
<b>Warranty</b> .....	10

## SAFETY INFORMATION

### Overview

The Firecom pantherCCS is a digital intercom designed for use in rugged, physical conditions and challenging acoustic environments. The durable construction, with recessed controls, is ideal for use on fire apparatus, emergency vehicles or any other mobile command equipment. The pantherCCS provides high volume, clear digital audio communication. NFPA 1500 standards require hearing protection for extreme noise environments over 98dB. Firecom headsets should be added to the intercom system for additional hearing protection.

The digital, two-wire system is designed to provide clear communication for all personnel with minimum connections. Multiple pantherCCS units may be installed in series to service a large network of stations without any loss of signal.

The remote unit, typically installed at the ladder tip, continuously transmits to base station units. Base station units include a Push-To-Talk (PTT) button to transmit to other intercom positions. Both the remote unit and base station are equipped with two headset jacks. With the addition of headsets, all personnel will have full two-way intercom communication, radio transmit and receive (requires an interface box), as well as 24db noise reduction to meet NFPA 1500 standards.

Radio transmit and receive can be added to the pantherCCS with the analog interface unit. The interface option provides full radio communications with either a Firecom "in-cab" intercom or with direct input from a two-way radio. The pantherCCS base stations keep personnel fully informed by monitoring radio traffic. In addition, all positions on the pantherCCS have radio transmit capability by using the PTT button on the Firecom headset.

Headphone jacks are provided for full duplex, hands-free communication, with the addition of Firecom headsets.



### WARNING



#### **Safety Information**

**Firecom's pantherCCS intercom speaker is loud enough to cause hearing damage. Use the volume control provided on the intercom to reduce the speaker volume to a safe level for the environment in which the intercom is being used or use Firecom headsets to reduce noise.**

## FEATURES

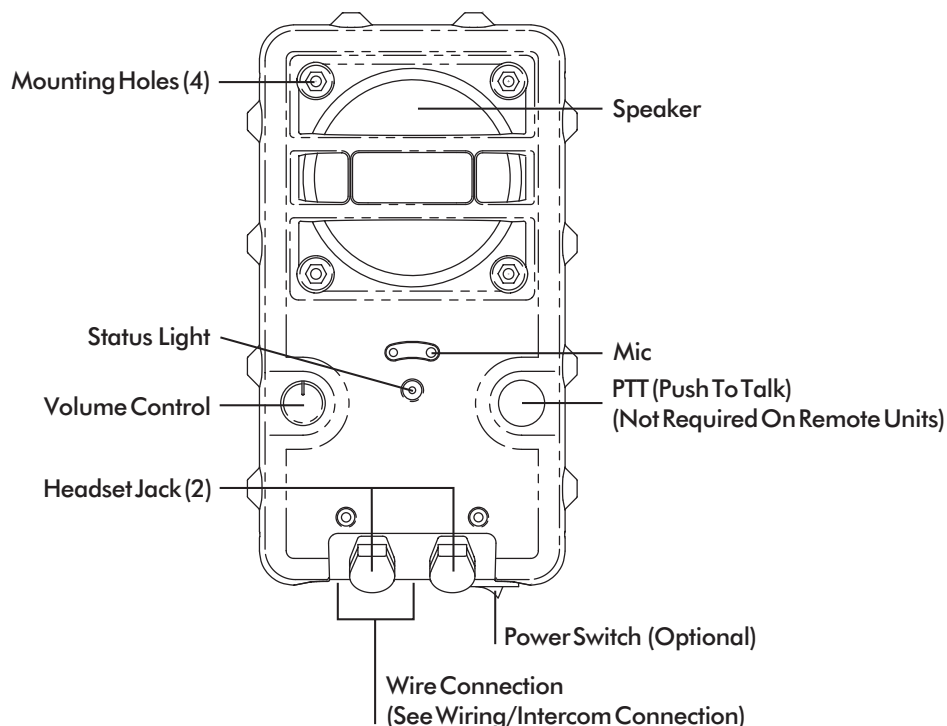

### Speaker

The speaker broadcasts audio when headsets are not used.

### Status Light

The status light illuminates when a station is operating properly. An internal diagnostic check is performed every time a unit is turned on.

### Volume Control

The volume knob controls the audio level of the speaker. It will not turn the audio off completely.

### Microphone

The microphone receives audio. It is activated by the PTT button on base stations and “live” on remote stations.

### Panel PTT Button

The PTT button activates the microphone on base stations and is not required on remote stations.

### Power Switch

The power switch is optional and controls station power. It will not affect other stations.

### Headset Jacks

Firecom headsets may be used in the headset jacks for hands-free, full-duplex communications or private broadcast. Additional radio or in-cab communications are available. See “Options and Accessories” section in this manual.

### Wire Connection

See “System Wiring” section in this manual.

### Mounting Holes

See “Installation/Mounting” section in this manual.

## INTERCOM MODELS

There are two pantherCCS intercom models: base stations and remote stations.

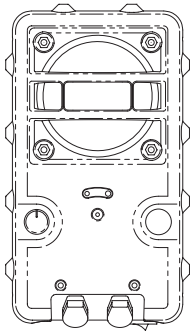

### Base Station

Base stations broadcast sound via a speaker when audio is provided from another unit. Depressing the PTT button activates the microphone and deactivates the speaker. When a headset is used, hands-free full-duplex communication is available. All parties need headsets for privacy.

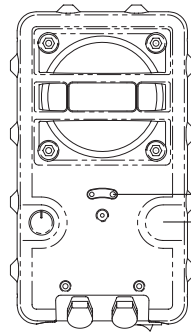

### Remote Station

Remote stations have "live" voice activated microphones that will always broadcast to other stations when sound is present. The speaker is activated only when other units are sending. When a headset is used, hands-free full-duplex communication is available for private broadcast.

"Live" Mic  
No PTT  
(Push To Talk)  
Required

## OPERATION

### Without headset

Base station audio is sent over the network to other stations when the panel PTT is depressed and sound is present on the microphone. When multiple stations are on a network, a "first come, first served" principle is employed between base stations with panel PTT buttons. Depressing a panel PTT button always disengages the respective station's speaker.

Remote stations employ voice activated microphones that transmit audio over the network when sound is present at the microphone. Audio from other stations will engage a remote speaker and disengage a remote microphone when sent via a panel PTT button.

### With headset

Headset usage provides hands-free full-duplex communications between stations. If two stations are using headsets, they will be able to talk and hear each other without depressing PTT buttons. Radio communication is possible with Firecom accessories (see "Options and Accessories" section in this manual).

If one base station is using a headset and others are not, speaking into the headset microphone will allow the user to be heard over other base station speakers. If the user is depressing the panel PTT and speaks into the headset microphone, the user's voice will transmit over remote station speakers. If a remote station is employing a headset and others are not, simply speaking into the headset microphone will allow the user to be heard over other station's speakers.

### Radio Communications

Radio broadcast and reception are available with the addition of a Firecom interface unit (see "Options and Accessories" section). Once an interface unit is installed on a network, radio communication is possible at every unit on the network. Incoming radio traffic will be heard on base station speakers and headsets at remote and base stations, but not heard on remote station speakers. A headset is required to transmit over the radio. Any headset, at any station, may transmit over the radio by simply pressing the red PTT button located on the headset, and speaking into the headset microphone. Use only Firecom headsets.

# INSTALLATION

The pantherCCS can be mounted on a flat surface using (4) bolts or studs. Bolt holes are provided in the pantherCCS housing that allow the unit to be secured to the selected mounting location using bolts or mounting studs.

## Mounting and Overall Dimensions

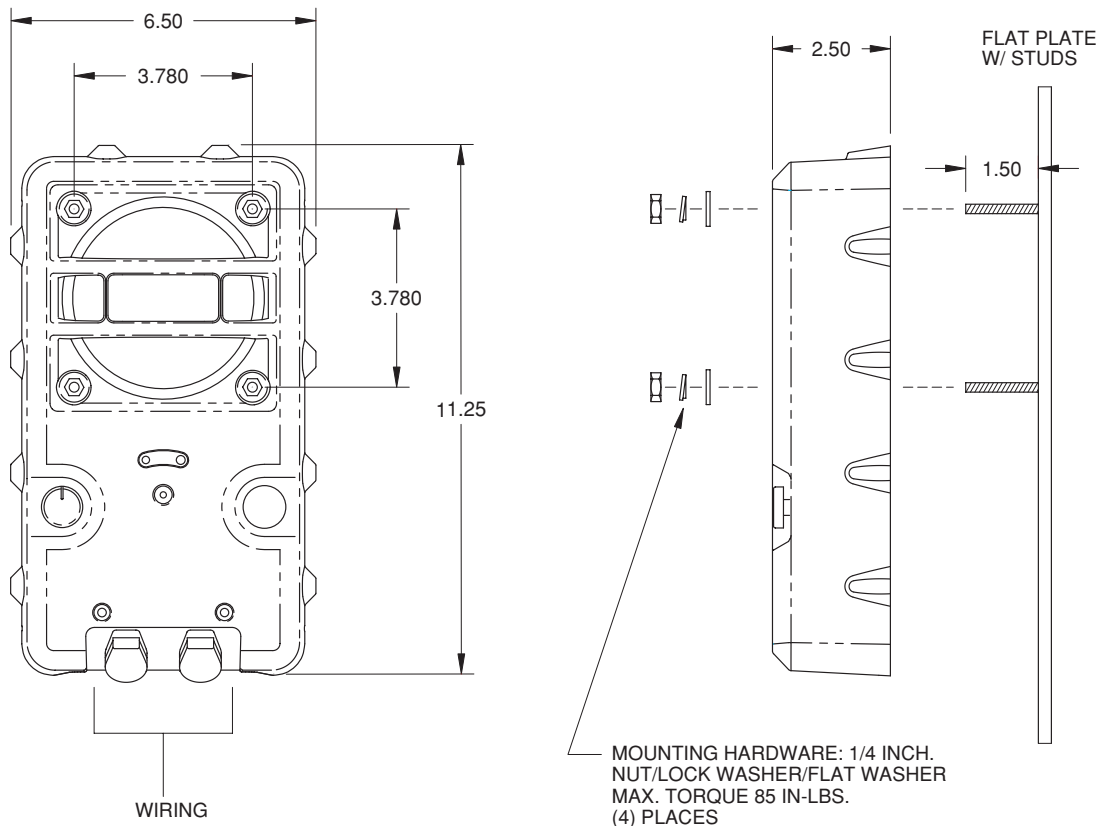

### Mounting Hardware (not provided)

- (4) 1/4 X 1-1/2 inch bolts or studs
- (4) flat washers
- (4) lock washers
- (4) nuts

Note: Flat washers are required for assembly against plastic housing



## WARNING



### Safety Information

Do not install unit on a flat, horizontal surface. If installed improperly, wet weather may cause water to pool in the microphone port, decreasing performance. Unit must be installed at an angle of 45 degrees or more.

# WIRE CONNECTIONS

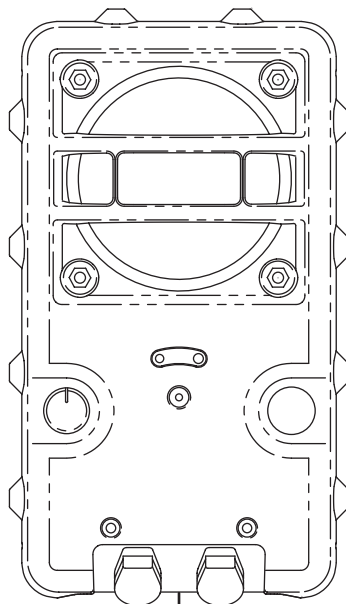

**Power**  
12 VDC (2.5 Amps maximum)

**Wire Size**  
**Power:** 18 gauge Min.  
**Network:** 22 gauge Min.  
(Shielded twisted pairs are optimal but not required.)

Cable Style

Bulkhead Conn. Style

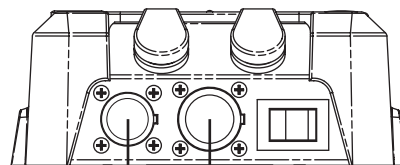
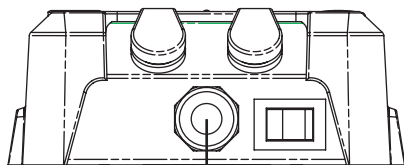

Cable 18/6

Deutsch Conn.  
HD10-3

Deutsch Conn.  
HD10-5

BLK • PWR (-)  
RED • PWR (+)  
WHT • Net (-)  
GRN • Net (+)  
ORG • Net (+)  
BLU • Net (-)

3A • N/A  
3B • PWR (-)  
3C • PWR (+)

5A • Net (-)  
5B • Net (+)  
5C • Shield  
5D • Net (+)  
5E • Net (-)

## SYSTEM WIRING

Over 100 devices can operate on one network, but only 8 full-duplex conversations can occur simultaneously.

The 2-wire network is connected by wiring intercoms in series. The positive network wire of one unit is connected to the positive network wire of the second unit. The negative network wires are connected similarly. Network wires between units must remain in pairs. Twisted pair wiring is preferred but not required. Both two unit wiring and multiple unit wiring are shown below. The ends of a network are always completed with a terminator.

### Two Unit Wiring

Wire Connection: **Cable / Deutsch Connectors** (see "Wire Connections" section for additional information).

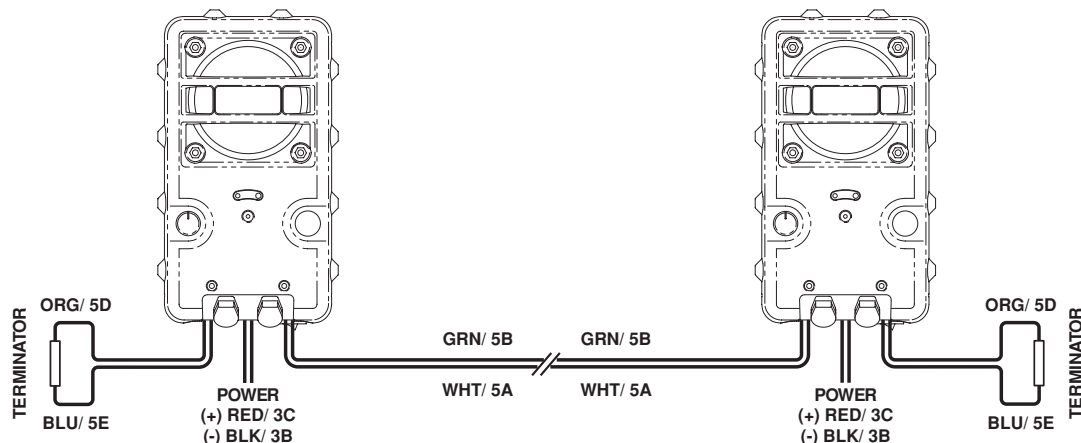

### Multiple Unit Wiring

Wire Connection: **Cable / Deutsch Connectors** (see "Wire Connections" section for additional information).

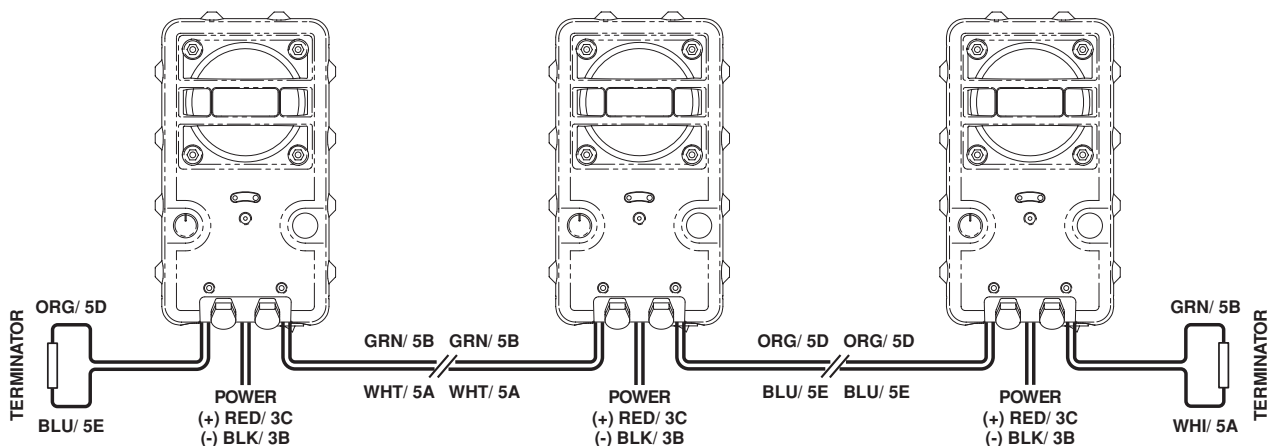

### Terminators

Two terminators are provided to complete a network circuit. The terminators are located at both ends of a network. For optimal performance, install terminators as close to the unit as possible and no further than 6 feet in wire length away. 51 Ohm terminators are available from Firecom (see "Options and Accessories" section).



## TROUBLESHOOTING

When properly installed and powered, a pantherCCS intercom network will perform reliably even in a harsh environment. If you believe one or more of your intercom units are malfunctioning, use the following troubleshooting information to locate the problem.

If the symptoms you are experiencing are not covered in this manual, or if you are having difficulty troubleshooting your system, contact your local Firecom dealer for assistance.

**Problem: One or more intercoms are not working.**

- Check that the status light is on for each intercom.

If status light is out:

Check that the power switch is on if it has one.

Check that the station has power connected to it. (See "Installation" section.)

Check that the network wiring is connected properly. (See "Installation" section.)

If status light is out, but power is being applied to the intercom, the intercom is malfunctioning and should be serviced by an intercom technician.

**Problem: Cannot hear voice traffic on the speaker of an intercom.**

- If there is a headset connected to the intercom unit, disconnect it.
- Adjust the volume control on the intercom.
- Be sure you are not pressing the PTT button while you are trying to listen.
- Check if other users can hear you talk on the intercom. If you can talk on the intercom but can not hear through the speaker, the intercom is malfunctioning and should be serviced by an intercom technician.

**Problem: Cannot talk through the intercom microphone.**

- If there is a headset connected to the intercom unit, disconnect it.
- Be sure to press the PTT button when talking from a base unit.
- If you are trying to talk on a remote unit, be sure you are speaking loudly enough to activate the voice-activated microphone.

**Can you hear traffic on the intercom through the speaker?**

1. If you can't talk or listen on the intercom, check the connection of the signal wires to your intercom unit.
2. If you can hear voice traffic on the intercom but cannot talk through the microphone, the intercom is malfunctioning and should be serviced by an intercom technician.

**Problem: When listening to an intercom with a headset, the sound is distorted or intermittent.**

- Clean the headset plug and jack with contact cleaner.
- Insert and remove the headset plug into the headset jack a few times to remove oxide build up on the contact.

**Problem: Noise or static is heard over the network.**

- Make sure the network connections are clean.
- Turn the unit off and back on after 5 seconds.

**Problem: Audio can be transmitted to, but not heard by, other units.**

- Check the terminators on the network. Make sure they are connected and have the proper resistance.

If a problem persists in a headset or intercom unit, contact Firecom for a Return Merchandise Authorization (RMA) number. Return the headset or intercom for replacement or repair.

**CONTACT:** Firecom 1-800-527-0555  
7340 SW Durham Road  
Portland, OR 97224  
USA

## OPTIONS AND ACCESSORIES

### **UH-10**

#### **Part No. 105-0192-00**

Under-helmet radio transmit headset. Adjustable volume, noise-canceling electret microphone, adjustable headstrap, flex-style boom rotates for left or right dress, comfortable liquid foam ear seals. 24dB NRR. (Red PTT located on dome.)

### **UH-10S**

#### **Part No. 105-0196-00**

Under-helmet headset, one slotted dome without speaker. Radio transmit capable. Noise-canceling electret microphone, flex-style boom rotates for right or left dress. (Red PTT.)

### **Terminators, Standard**

#### **108-0051-00**

Network terminators used with pantherCCS 2-wire networks.

Qty (2) per package

### **Terminators, Deutsch Connector**

#### **108-0052-00**

Network terminators used with pantherCCS 2-wire networks incorporating Deutsch HD-10 style connectors. These terminators install into the unit's mating plug.

Qty (2) per package

### **Cable Connectors, Deutsch**

#### **107-0500-05**

A set of mating cable connectors for use with pantherCCS Deutsch style bulk head connector units. Two connectors and pins included.

### **Analog Interface, 30xx Intercom & Single Radio**

#### **108-0510-00**

This unit allows the addition of a Firecom 30xx intercom and an optional radio to the pantherCCS 2-wire network. With the integration of this unit anyone on the 2-wire network will be able to send and receive radio communications as well as talk to anyone on a Firecom 30xx intercom.

### **DR-1C**

#### **108-0671-10**

This is a selector switch box that allows a user to toggle between two independent radios for transmission and reception.

### **HE-150**

#### **108-0675-00**

15' coiled headset extension cable for use with any single-plug headset for greater mobility at pump panel position.

## MAINTENANCE

Clean headset jacks as required.

## WARRANTY

### Two-Year Limited Warranty to the Original Purchaser

Sonetics Corporation warrants to the original purchaser of its products, that they will be free from defects in materials and workmanship, under normal and proper use, for the period of two years from date of purchase. Sonetics Corporation will repair or replace, at its option, any parts showing factory defects during this warranty period, subject to the following provisions. This warranty applies only to a new product which has been sold through authorized channels of distribution. All work under warranty must be performed by Sonetics Corporation. All returned products must be shipped to our address, freight prepaid, accompanied by a dated proof of purchase. The purchaser voids this warranty if he, she or others attempt to repair, service or alter the product in any way. This warranty does not apply in the event of accident, abuse, improper installation, unauthorized repair, tampering, modification, fire, flood, collision, or other damage from external sources, including damage which is caused by user replaceable parts (leaking batteries, etc.). This warranty does not extend to any other equipment or apparatus to which this product may be attached or connected. The foregoing is your sole remedy for failure in service or defects. Sonetics Corporation shall not be liable under this or any implied warranty for incidental or consequential damages, nor for any installation or removal costs or other service fees. This warranty is in lieu of all other warranties, express or implied, including the warranty of merchantability or fitness of use, which are hereby excluded. To the extent that this exclusion is not legally enforceable, the duration of such implied warranties shall be limited to two years from date of purchase. No suit for breach of express or implied warranty may be brought after two years from date of purchase.



### WARNING



#### Safety Information

**Firecom's pantherCCS intercom speaker is loud enough to cause hearing damage. Use the volume control provided on the intercom to reduce the speaker volume to a safe level for the environment in which the intercom is being used or use Firecom headsets to reduce noise.**



**FIRECOM** is a division of Sonetics Corporation  
7340 SW Durham Road • Portland, Oregon 97224  
800-527-0555 • 503-684-6647 • Fax: 503-620-2943  
Email: [sales@firecom.com](mailto:sales@firecom.com) • [www.firecom.com](http://www.firecom.com)

Copyright © 2004 Sonetics Corporation - All rights reserved.  
The information in this document is subject to change without notice.  
No part of this document may be reproduced in any form without prior written consent of Sonetics Corporation.  
This document is part number 600-0500-00 RevB. Printed in U.S.A.